iTC-11XX Series

iTC-1101C / iTC-1121R / iTC-1150R / iTC-1170R

**Fanless Industrial Panel PC with
Intel® Elkhart Lake Processor**

User's Manual

Version 1.3

Revision History

Version	Date	Description
1.0	2022.03	Initial release
1.1	2022.04	Modify the dimension on P.4
1.2	2022.08	Add Specification and dimension of iTC-1170R
1.3	2023.05	Modify the View Angle in 1.3 Specifications

Revision History	ii
Contents	i
Preface.....	iii
Copyright Notice	iii
Declaration of Conformity	iii
CE.....	iii
FCC Class A	iii
RoHS	iv
SVHC / REACH	iv
Important Safety Instructions	v
Warning.....	vi
Lithium Battery Replacement.....	vi
Technical Support	vi
Warranty.....	vii
Chapter 1 - Introduction.....	1
1.1. The Computer	2
1.2. About this Manual	2
1.3. Specifications.....	3
1.4. Inside the Package	6
Chapter 2 - Getting Started.....	7
2.1. Dimensions	8
2.2. Tour the Computer	10
2.2.1. Front View.....	10
2.2.2. Bottom View.....	10
2.2.3. Side View.....	11
2.3. I/O Definition	13
2.4. Driver Installation Note.....	15
Chapter 3 - Engine of the Computer.....	17
3.1. Board Layout.....	18
3.2. Pin Header	20
3.2.1. Pin Header	20
Chapter 4 - Installation and Maintenance.....	21
4.1.1 Remove the Rear Cover from the device	22
4.1.2. Install Wi-Fi Module	23
4.1.3 Install the M.2 SSD Module	28
4.1.4. Install SSD or HDD (iTC-1121R / iTC-1150R)	30
4.2. Mount the Computer	32
4.2.1. iTC-1101C Panel Mounting.....	32
4.2.2. iTC-1101C VESA Mounting (Optional Accessory)	33

4.2.3. iTC-1121R / iTC-1150R / iTC-1170R Panel Mounting	34
4.2.4. iTC-1121R / iTC-1150R / iTC-1170R VESA Mounting	35
(Optional Accessory).....	35
Chapter 5 - BIOS	37
5.1. Main	40
5.2. Advanced	41
5.2.1. CPU Configuration.....	42
5.2.2. Trusted Computing	43
5.2.3. ACPI Settings.....	44
5.2.4. Super IO Configuration	45
5.2.5. Hardware Monitor	46
5.2.6. S5 RTC Wake Settings	47
5.2.7. PCI Subsystem Setting.....	48
5.2.8. USB Configuration	49
5.2.9. Network Stack Configuration	51
5.2.10. NVME Configuration	52
5.3. Chipset.....	53
5.3.1. Graphics Configuration.....	55
5.3.2. SATA And RST Configuration	56
5.3.3. USB Configuration	57
5.4. Security	58
5.4.1. Security Boot	59
5.5. Boot.....	60
5.6. Save & Exit	62

Copyright Notice

All Rights Reserved.

The information in this document is subject to change without prior notice in order to improve the reliability, design and function. It does not represent a commitment on the part of the manufacturer.

Under no circumstances will the manufacturer be liable for any direct, indirect, special, incidental, or consequential damages arising from the use or inability to use the product or documentation, even if advised of the possibility of such damages.

This document contains proprietary information protected by copyright. All rights are reserved. No part of this document may be reproduced by any mechanical, electronic, or other means in any form without prior written permission of the manufacturer.

Declaration of Conformity

CE

The CE symbol on your product indicates that it is in compliance with the directives of the Union European (EU). A Certificate of Compliance is available by contacting Technical Support.

This product has passed the CE test for environmental specifications when shielded cables are used for external wiring. We recommend the use of shielded cables. This kind of cable is available from ARBOR. Please contact your local supplier for ordering information.

Warning

This is a class A product. In a domestic environment this product may cause radio interference in which case the user may be required to take adequate measures.

FCC Class A

This device complies with Part 15 of the FCC Rules. Operation is subject to the following two conditions:

- (1) This device may not cause harmful interference, and
- (2) This device must accept any interference received, including interference that may cause undesired operation.

NOTE:

This equipment has been tested and found to comply with the limits for a Class A digital device, pursuant to Part 15 of the FCC Rules. These limits are designed to provide reasonable protection against harmful interference when the equipment is operated in a commercial environment. This equipment generates, uses, and can radiate radio frequency energy and, if not installed and used in accordance with the instruction manual, may cause harmful interference to radio communications. Operation of this equipment in a residential area is likely to cause harmful interference in which case the user will be required to correct the interference at his own expense.

RoHS

ARBOR Technology Corp. certifies that all components in its products are in compliance and conform to the European Union's Restriction of Use of Hazardous Substances in Electrical and Electronic Equipment (RoHS) Directive 2002/95/EC.

The above mentioned directive was published on 2/13/2003. The main purpose of the directive is to prohibit the use of lead, mercury, cadmium, hexavalent chromium, polybrominated biphenyls (PBB), and polybrominated diphenyl ethers (PBDE) in electrical and electronic products. Member states of the EU are to enforce by 7/1/2006.

ARBOR Technology Corp. hereby states that the listed products do not contain unintentional additions of lead, mercury, hex chrome, PBB or PBDB that exceed a maximum concentration value of 0.1% by weight or for cadmium exceed 0.01% by weight, per homogenous material. Homogenous material is defined as a substance or mixture of substances with uniform composition (such as solders, resins, plating, etc.). Lead-free solder is used for all terminations (Sn(96-96.5%), Ag(3.0-3.5%) and Cu(0.5%)).

SVHC / REACH

To minimize the environmental impact and take more responsibility to the earth we live, Arbor hereby confirms all products comply with the restriction of SVHC (Substances of Very High Concern) in (EC) 1907/2006 (REACH --Registration, Evaluation, Authorization, and Restriction of Chemicals) regulated by the European Union.

All substances listed in SVHC < 0.1 % by weight (1000 ppm)

Important Safety Instructions

Read these safety instructions carefully

1. Read all cautions and warnings on the equipment.
2. Place this equipment on a reliable surface when installing. Dropping it or letting it fall may cause damage
3. Make sure the correct voltage is connected to the equipment.
4. For pluggable equipment, the socket outlet should be near the equipment and should be easily accessible.
5. Keep this equipment away from humidity.
6. The openings on the enclosure are for air convection and protect the equipment from overheating. **DO NOT COVER THE OPENINGS.**
7. Position the power cord so that people cannot step on it. Do not place anything over the power cord.
8. Never pour any liquid into opening. This may cause fire or electrical shock.
9. Never open the equipment. For safety reasons, the equipment should be opened only by qualified service personnel.
10. If one of the following situations arises, get the equipment checked by service personnel:
 - a. The power cord or plug is damaged.
 - b. Liquid has penetrated into the equipment.
 - c. The equipment has been exposed to moisture.
 - d. The equipment does not work well, or you cannot get it to work according to the user's manual.
 - e. The equipment has been dropped or damaged.
 - f. The equipment has obvious signs of breakage.
11. Keep this User's Manual for later reference.

Warning

The Panel PC and its components contain very delicately Integrated Circuits (IC). To protect the Panel PC and its components against damage caused by static electricity, you should always follow the precautions below when handling it:

1. Disconnect your Panel PC from the power source when you want to work on the inside.
2. Use a grounded wrist strap when handling computer components.
3. Place components on a grounded antistatic pad or on the bag that came with the Panel PC, whenever components are separated from the system.

Lithium Battery Replacement

Incorrect replacement of the lithium battery may lead to a risk of explosion.

The lithium battery must be replaced with an identical battery or a battery type recommended by the manufacturer.

Do not throw lithium batteries into the trash can. It must be disposed of in accordance with local regulations concerning special waste.

Technical Support

If you have any technical difficulties, please consult the user's manual first at:
<http://www.arbor.com.tw>

Please do not hesitate to call or e-mail our customer service when you still cannot find out the answer.

<https://www.arbor-technology.com>

Warranty

This product is warranted to be in good working order for a period of one year from the date of purchase. Should this product fail to be in good working order at any time during this period, we will, at our option, replace or repair it at no additional charge except as set forth in the following terms. This warranty does not apply to products damaged by misuse, modifications, accident or disaster.

Vendor assumes no liability for any damages, lost profits, lost savings or any other incidental or consequential damage resulting from the use, misuse of, or inability to use this product. Vendor will not be liable for any claim made by any other related party.

Vendors disclaim all other warranties, either expressed or implied, including but not limited to implied warranties of merchantability and fitness for a particular purpose, with respect to the hardware, the accompanying product's manual(s) and written materials, and any accompanying hardware. This limited warranty gives you specific legal rights.

Return authorization must be obtained from the vendor before returned merchandise will be accepted. Authorization can be obtained by calling or faxing the vendor and requesting a Return Merchandise Authorization (RMA) number. Returned goods should always be accompanied by a clear problem description.

This page is intentionally left blank.

Chapter 1

Introduction

1.1. The Computer

Product Highlights

(*Product appearance varies by model.)

- Intel® Celeron® Processor J6413 (1.5M Cache, up to 3.00 GHz)
- 10.1" 1280 x 800 WXGA LCD display
- 12.1" & 15" 1024 x 768 XGA LCD display
- 17" 1280 x 1024 SXGA
- Fanless design w/ Aluminum Front bezel
- Flush front panel w/ IP65 waterproof compliant
- Support 2.5GbE LAN and USB 3.2 Gen1 (5Gbps)
- Rich I/O: 4 x COM/ 2 x LAN/ 4 x USB3.2(5Gbps)
/ 8-bit DI/O & dual video output: DisplayPort and DVI-D
- Easy-accessible expansion for storage and wireless module.
- 9~36V wide-range DC input with reverse protection



1.2. About this Manual

This manual is meant for the experienced users and integrators with hardware knowledge of personal computers. If you are not sure about the description in this manual, consult your vendor before further handling.

We recommend that you keep one copy of this manual for the quick reference for any necessary maintenance in the future. Thank you for choosing ARBOR products.

1.3. Specifications

System		
CPU	Intel® Celeron® J6413 Quad-Core™ Processor 1.80GHz	
Memory	1 x 260 pin DDR4 SO-DIMM socket, supporting 3200MHz SDRAM up to 32GB (4GB DDR4 SO-DIMM pre-installed)	
LAN Chipset	1 x Intel® 225LM controller 1 x Intel® i211AT controller	
Watchdog Timer	1~255 levels reset	
Storage		
Device	1 x M.2 M-Key 2242/ 2280 (SATAIII only) 2nd Storage Device: 1 x 2.5" SSD/ HDD tray (For iTC-1121R/ iTC-1150R/ iTC-1170R)	
Audio		
Device	1x Mic-in / 1x Line out	
Speaker	2 x 1.5W speakers (optional)	
LCD Display		
Size/Type	iTC-1101C	10.1" TFT LCD Panel
	iTC-1121R	12.1" TFT LCD Panel
	iTC-1150R	15" TFT LCD Panel
	iTC-1170R	17" TFT LCD Panel
Max. Resolution	iTC-1101C	1280 x 800 WXGA
	iTC-1121R	1024 x 768 XGA
	iTC-1150R	1024 x 768 XGA
	iTC-1170R	1280 x 1024 SXGA
Max. Colors	iTC-1121R/iTC-1150R: 16.2M	
	iTC-1101C/iTC-1170R: 16.7M	
Luminance	iTC-1101C, iTC-1150R, iTC-1170R	350 cd/m ²
	iTC-1121R	500 cd/m ²
Touch Screen	iTC-1101C: Projected Capacitive touch	
	iTC-1121R/ iTC-1150R/ iTC-1170R: Flat 5-wire Analog Resistive	
View Angle (U/D/R/L)	iTC-1101C: 85°/85°/85°/85°	
	iTC-1121R: 89°/89°/89°/89°	
	iTC-1150R: 88°/88°/88°/88°	
	iTC-1170R: 60°/80°/80°/80°	
Power System		
Power Input	DC 9~36V	
Power Consumption	iTC-1101C: 19W (typical)	
	iTC-1121R: 25W (typical)	
	iTC-1150R: 25W (typical)	
	iTC-1170R: 39.1W(typical)	

Qualification		
Certification	CE, FCC Class A	
Expansion		
Expansion Bus	1 x Mini PCIe slot (PCIe x1+ USB2.0, Full size) w/ 1 x SIM card slot	
External I/O		
Serial Ports	iTC-1101C: 2 x DB-9 connectors for RS232/422/485 Optional: 2 x DB-9 connectors for RS232 via cables iTC-1121R / iTC-1150R / iTC-1170R: 2 x DB-9 connectors for RS232/422/485 2 x DB-9 connectors for RS232	
USB Ports	4 x Type-A USB 3.2 Gen 1 (5Gbps)	
LAN	1 x RJ-45 port for GbE LAN 1 x RJ-45 port for 2.5 GbE LAN	
Video Ports	1 x DVI-D connector, supporting Full HD resolution 1 x DisplayPort 1.4 connector, supporting 4K2K resolution	
DIO	8 bit Digital I/O	
Mechanical		
Mounting Type	Panel mount (clamps & brackets are provided) VESA-75/100 mount (optional)	
Chassis	Aluminum front bezel and steel-metal chassis	
Dimension (W x H x D)	iTC-1101C	255 x 175 x 62.8 mm
	iTC-1121R	315 x 260 x 68.8 mm
	iTC-1150R	367 x 299 x 68.8 mm
	iTC-1170R	415 x 347 x 70 mm
Weight (Net)	iTC-1101C	2.35 kg
	iTC-1121R	3.6 kg
	iTC-1150R	4.5 kg
	iTC-1170R	6.1kg
Environmental		
Operating Temp.	-10°C ~ 55°C (14°F ~ 131°F)	
Storage Temp.	-20°C ~ 70°C (-4°F ~ 158°F)	
Operating Humidity	10 ~ 95% RH @ 55°C (non-condensing)	
Vibration	5 ~ 500Hz, 1Grms Random (w/ mSATA)	
Shock	Operating 10G, 11ms X,Y,Z axis (with SSD)	
OS Support		
Windows®10 (64bit)		

1.4. Inside the Package

Upon opening the package, carefully inspect the contents. If any of the items is missing or appears damaged, contact your local dealer or distributor. The package should contain the following items:

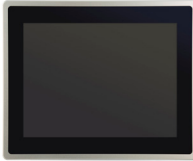

1 x iTC-1101C / iTC-1121R /
iTC-1150R / iTC-1170R
*Product appearance varies by model.

iTC-1101C Accessory Box

1 x **Accessory Box** that contains the following items:

- User Manual
- Panel-mount Bracket w/ screws (2 x Brackets and 4 x M3*6L screws)
- Panel-mount Clamps w/ screws (4 x clamps and 4 x M4*18L screws)
- 10-pin plug (for D I/O)
- 3-pin plug x 2 (one for DC input block; one for Remote Control block)

iTC-1121R / iTC-1150R / iTC-1170R Accessory Box

1 x **Accessory Box** that contains the following items:

- User Manual
- 4 x M3*4L screws (for 2.5" SSD/ HDD tray)
- Panel-mount Clamps w/ screws (8 x clamps and 8 x M4*18L screws)
- 10-pin plug (for D I/O)
- 1 x Rubber O-ring
- 3-pin plug x 2 (one for DC input block; one for Remote Control block)

This page is intentionally left blank.

Chapter 2

Getting Started

2.1. Dimensions

ITC-1101C

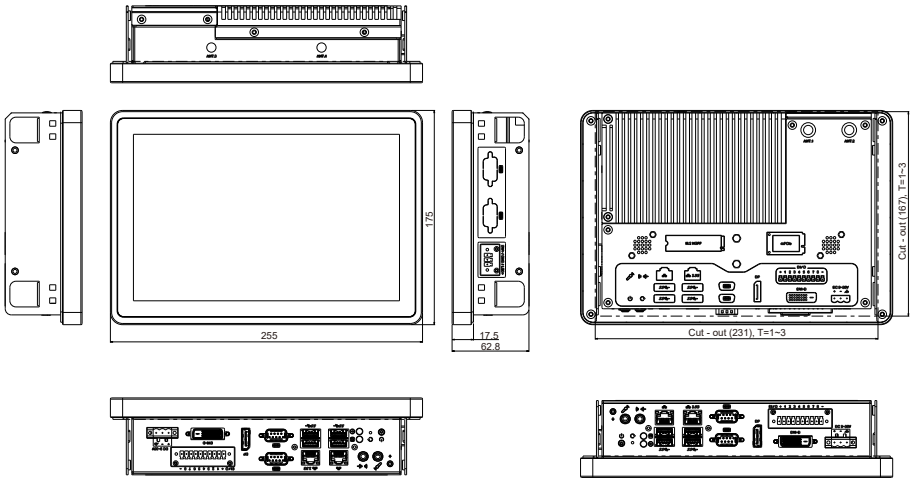

ITC-1121R

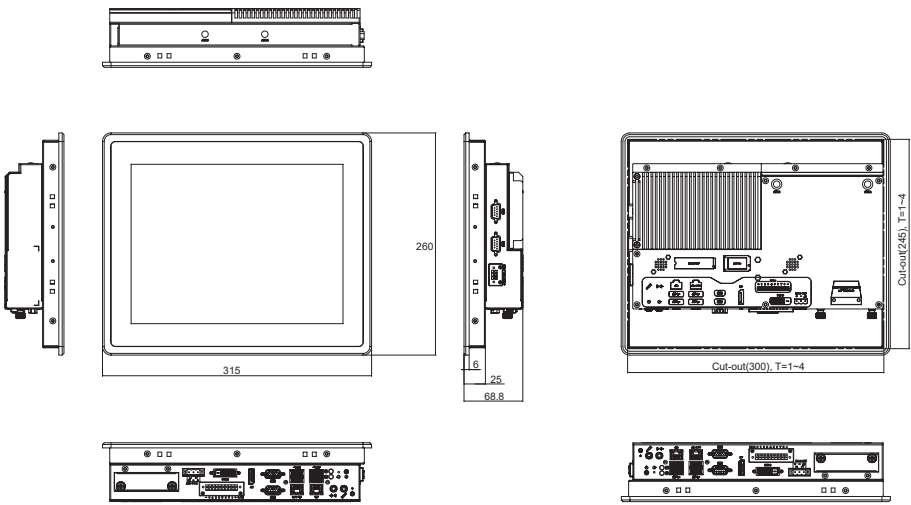

iTC-1150R

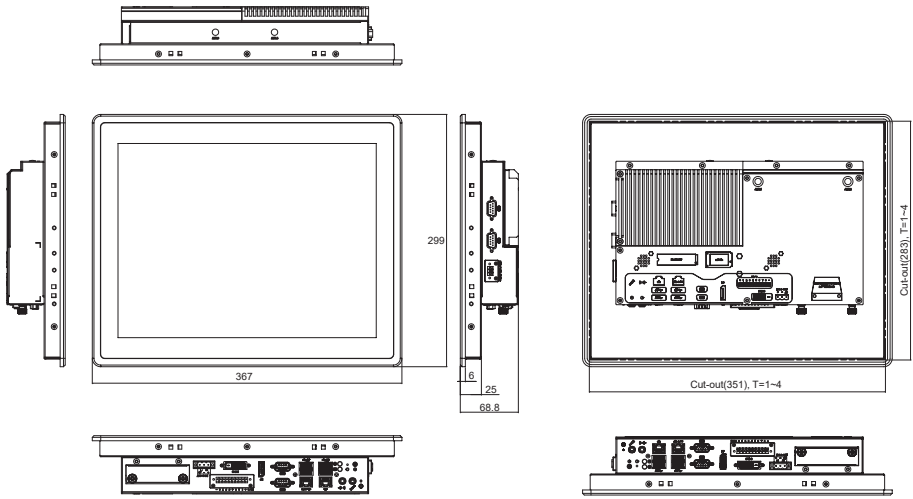

iTC-1170R

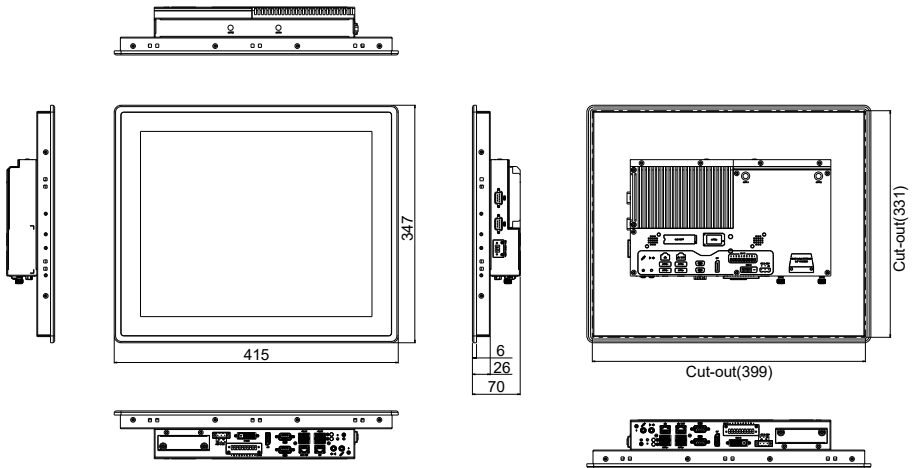

2.2. Tour the Computer

Take a look around the computer and find the external controls and connectors.

2.2.1. Front View



*Product appearance varies by model.

2.2.2. Bottom View

iTC-1121R / iTC-1150R / iTC-1170R

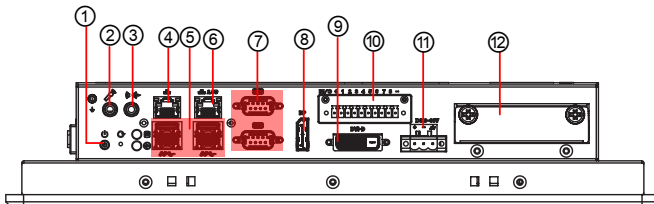

iTC-1101C

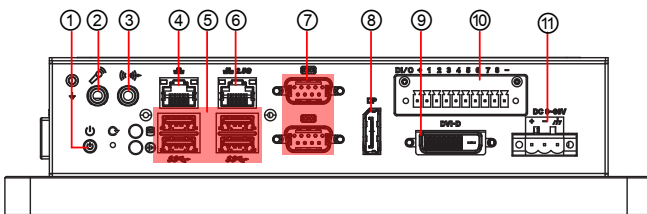

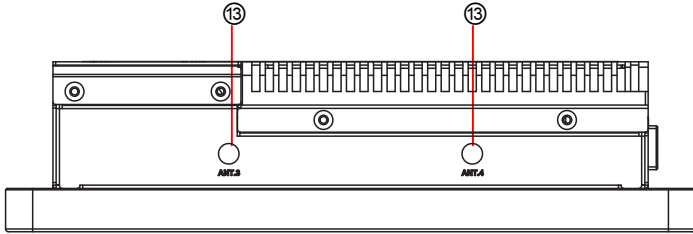

2.2.3. Side View

iTC-1101C

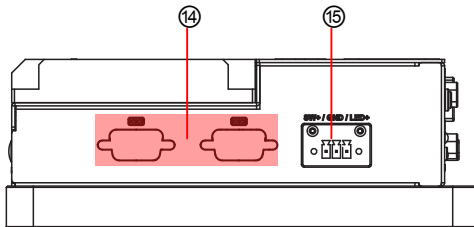

iTC-1121R / iTC-1150R / iTC-1170R

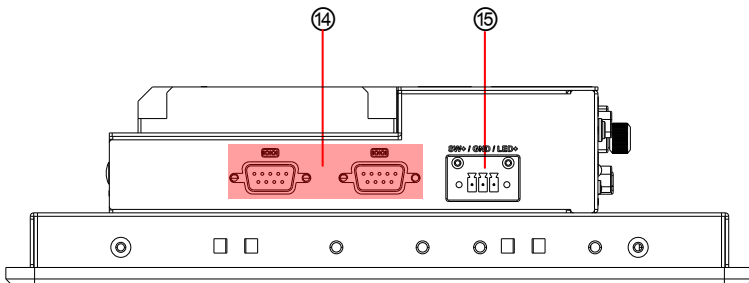

iTC-1101C / iTC-1121R / iTC-1150R / iTC-1170R

No.	Description
①	Power button
②	1 x Mic-in
③	1 x Line out
④	1 x RJ-45 GbE port
⑤	4 x Type-A USB 3.0/2.0 ports
⑥	1 x RJ-45 2.5G GbE port
⑦	COM1, COM2, RS-232/422/485 selectable
⑧	1 x DisplayPort 1.4 connector, supporting 4K2K resolution
⑨	1 x DVI-D connector, supporting Full HD resolution
⑩	8 bit Digital I/O
⑪	3-pin terminal block for Power Input
⑫	1 x 2.5" SSD/ HDD tray
⑬	SMA Antenna Holes for optional WiFi Function
⑭	RS232 x 2 (Optional for iTC-1101C/ via cables)
⑮	1x3-pin terminal block for remote control and PWR LED output

2.3. I/O Definition

⑦ ⑭ COM1, COM2 and RS232

Function: RS-232/422/485 Selectable Serial Port

Connector Type: External 9-pin D-sub male connector

Pin Assignment:

	Pin	Desc.	Pin	Desc
RS-232	1	DCD	6	DSR
	2	RXD	7	RTS
	3	TXD	8	CTS
	4	DTR	9	RI
	5	GND		
RS-422	1	COM_422 TX-		
	2	COM_422 TX+		
	3	COM_422 RX+		
	4	COM_422 RX-		
	5	GND		
RS-485	1	COM_485 D-		
	2	COM_485 D+		
	5	GND		

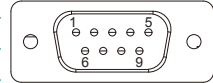

⑩ 8 bit Digital I/O

Function: Digital I/O Connector

Connector Type:

Pin Assignment:

Pin	Desc.	Pin	Desc.
+	DIO_POWER	5	GPIO81
1	GPIO80	6	GPIO83
2	GPIO82	7	GPIO85
3	GPIO84	8	GPIO87
4	GPIO86	-	GND

DI/O



⑪ PWRIN1

Function: Power input terminal block

Connector Type: 1x3-pin Terminal block

Pin Assignment:

Pin	Desc.
1	Power Input +
2	Power Input -
3	Earth Ground

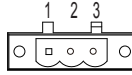

⑮ 3-pin terminal block

Function: 3-pin terminal block for remote control and PWR LED

Connector Type: 1x3-pin Terminal block

Pin Assignment:

Pin	Desc.
1	Power button+
2	GND
3	LED+

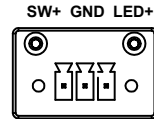

2.4. Driver Installation Note

Windows 10 64-Bit

To install the drivers, please visit our website at **www.arbor-technology.com** and download the driver pack from the product page. If you need login access, please contact your local ARBOR sales representative.

Device	Driver Path
Audio	Audio\0006-64bit_Win7_Win8_Win81_Win10_R279.exe
Ethernet	Ethernet\Wired_driver_26.3_x64.exe
Graphic	Graphic\Installer.exe
Intel_CSE	Intel_CSE\SetupME.exe
Intel_HID Event Filter	Intel_HID Event Filter\Installer\Setup.exe
Intel_Serial IO	Intel_Serial IO\616361_serialIO_driver_Windows10_64bit_ElkhartLake_RelNotes.pdf (Please check page 12 of RelNotes.pdf file to install the driver)
PenMount Touch Driver	PenMount Touch Driver\Setup.exe (Only apply to iTC-1121R / iTC-1150R and iTC-1170R)

This page is intentionally left blank.

Chapter 3

Engine of the Computer

3.1. Board Layout

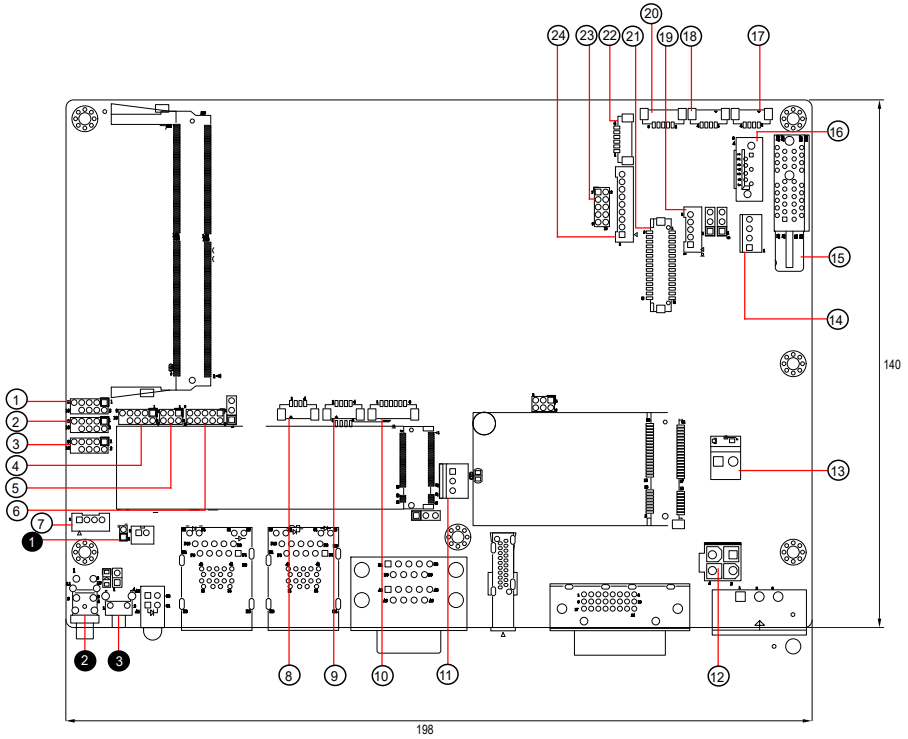

198

140

Pin Headers

Label	Description
① JBAT1	CMOS Settings

Buttons

Label	Description
② SW1	Power Button
③ CN3	Reset Button

Connectors



Label	Description
① ② ③ ④ CN12, CN11, CN14, CN13	COM Ports
⑤ JPIC1	PIC programming pin header
⑥ CN15	Digital I/O Connector
⑦ CN2	Remote button and LED
⑧ ⑨ CN8, CN9	USB Connector
⑩ CN4	SMBUS Connector
⑪ FAN1	FAN Connector
⑫ JPOWER1	Power Input connector
⑬ JPOWER2	Power Output connector
⑭ SATAPWR	SATA Power Connector
⑮ PCIe1	PCIe Connector
⑯ SATA1	Serial ATA Connector
⑰ ⑱ CN6, CN7	USB Connector
⑲ INV1	LVDS Back light Connector
⑳ TPC1	Resistive Touch Connector
㉑ LVDS1	LVDS Connector
㉒ CN16	AUDIO Connector
㉓ DGP1	Debug Port
㉔ CN5	HDA Connector

3.2. Pin Header

3.2.1. Pin Header

❶ JBAT1

Function: Clears/keeps CMOS
Jumper Type: 2.00 mm pitch 1x2-pin header
Setting:

Pin	Description
Short	Clears CMOS
	
Open	Keeps CMOS (default)
	

Chapter 4

Installation & Maintenance

4.1.1 Remove the Rear Cover from the device

1. Loosen and remove the 6 screws securing the computer's rear cover.



2. Dismount the rear cover from the computer. The inside of the computer comes to view.



4.1.2. Install Wi-Fi Module

1. Locate the **Mini PCIe** socket for wireless module. Note the socket has a break among the connector.

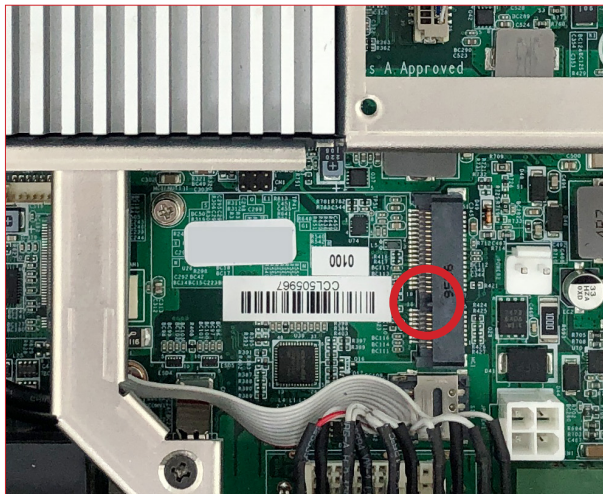
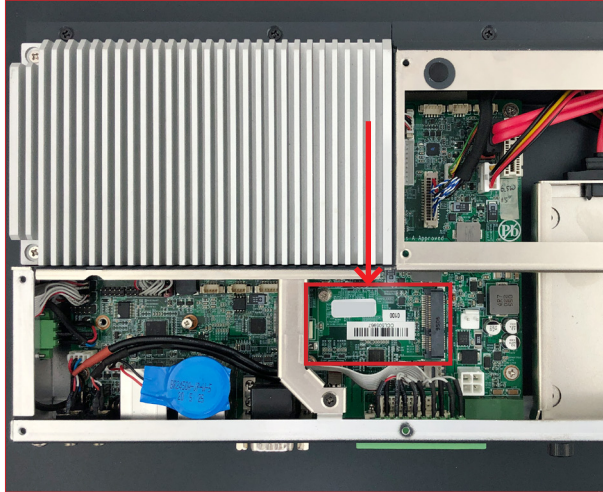

2. Connect the antenna to your wireless module. The wireless module comes with two U.FL connectors - one is "1" and the other is "0". Always follow the

connections below for best signal reception.

If you are using only one antenna, connect the antenna's MHF end to the connector labeled "1".

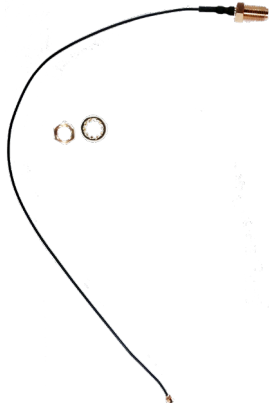

Two U.FL connectors, one is "MAIN" (marked 2), the other is "AUX" (marked 1).



3. Then plug the Wi-Fi module to the socket's connector by a slanted angle. Fully insert the module, and note that the notch on the wireless module should meet the break of the connector.

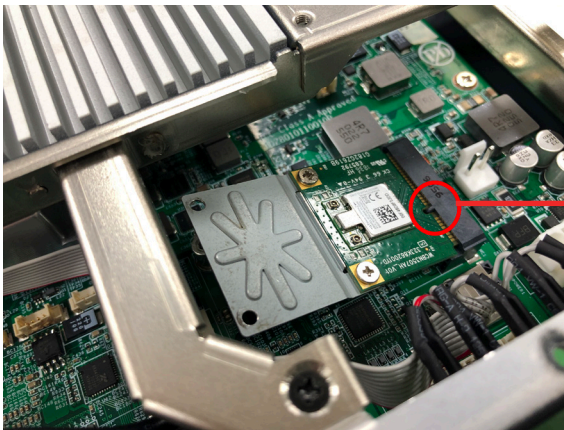

The module's key notch should meet the connector's break.

4. Press the module down and fix the module in place using the screw.

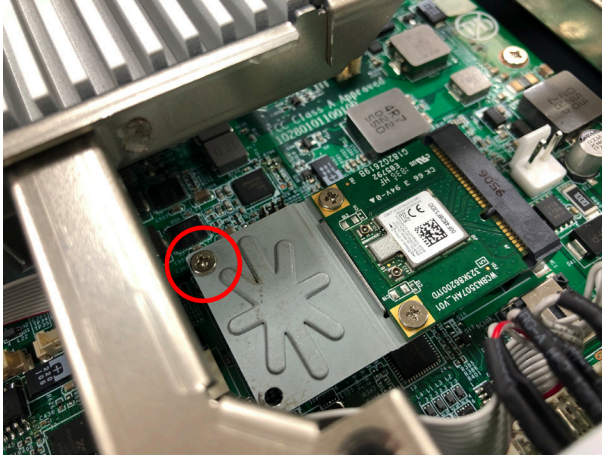

5. Remove a plastic plug from the computer's bottom side to make an antenna hole. Keep the plastic plug for any possible restoration in the future.



6. From the SMA end of the RF antenna, remove the washer and the nut. Save the washer and nut for later use. Note that the SMA connector is in the form of a threaded bolt, with one flat side.

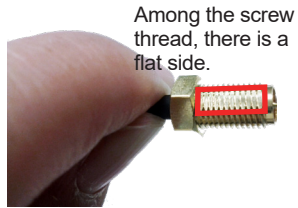
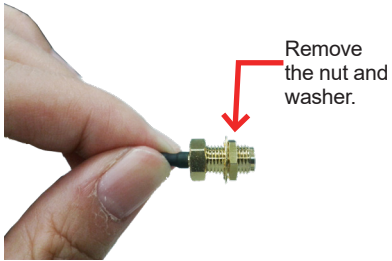

7. Pass the SMA connector through the above mentioned antenna hole. Make sure that you align the connector's flat side with the antenna hole's flat side.

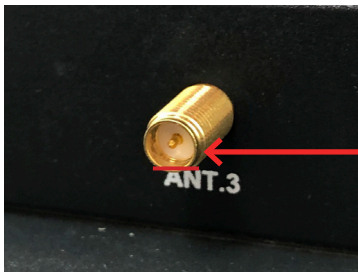

Arrange the flat side of the SMA connector to meet the flat side of the antenna hole.

8. Mount the washer first and then the nut to the SMA connector. Make sure the nut is tightened.



Mount the washer and the nut to the SMA connector. Tighten the nut.

9. Have the external antenna(s). Screw and tightly fasten the antenna(s) to the SMA connector.



4.1.3 Install the M.2 SSD Module

1. Locate the **SSD** socket. Note that the socket has a break among the connector. The module's key notch should meet the connector's break.

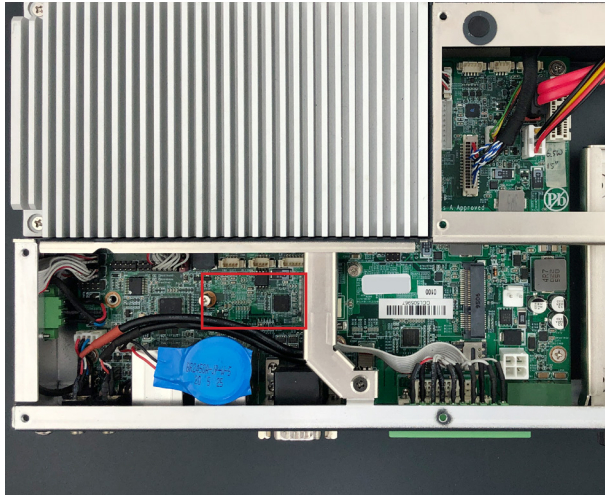

2. Confront the SSD module's edge connector with the socket's connector. Align the module's key notch with the connector's break and fully plug the module.



3. Press the module down and fix the module in place with one screw.

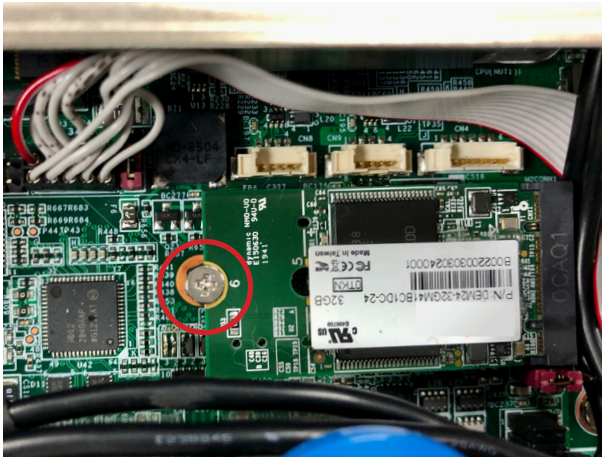

4.1.4. Install SSD or HDD (iTC-1121R / iTC-1150R / iTC-1170R)

The iTC-1121R / iTC-1150R / iTC-1170R comes with one 2.5" drive bays for 2.5" HDD or SSD storage device. To install 2.5" HDD or SSD to the computer,

1. Locate the 2.5" drive bays inside the computer. Loosen and remove the screw that locks the door and take the bracket out of computer.



2. Slide the HDD/SSD storage device into the bracket.



3. Fix the storage device in place by fastening the four screws of the bracket.

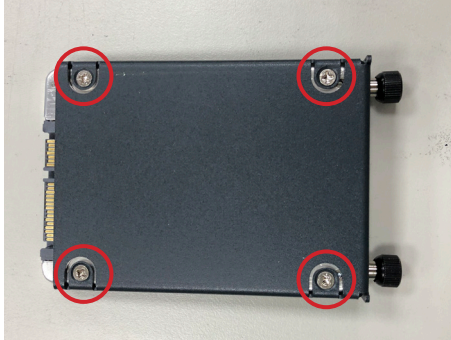

4. Slide the bracket back to the computer.

4.2. Mount the Computer

Install the panel PC to where it works by mounting it to a wall.

4.2.1. iTC-1101C Panel Mounting

1. Have the panel-mount brackets included in accessory pack. Put two brackets on the edge of panel PC and tightly fasten 4 screws.
2. Integrate the panel PC into a correct-sized frame on a wall or other devices.
3. Put the provided panel-mounting bracket and clamps into holes around edges of the panel PC as the picture below.

Note: In our case, we took a transparent stand as an example.

Panel Mount and Clamps

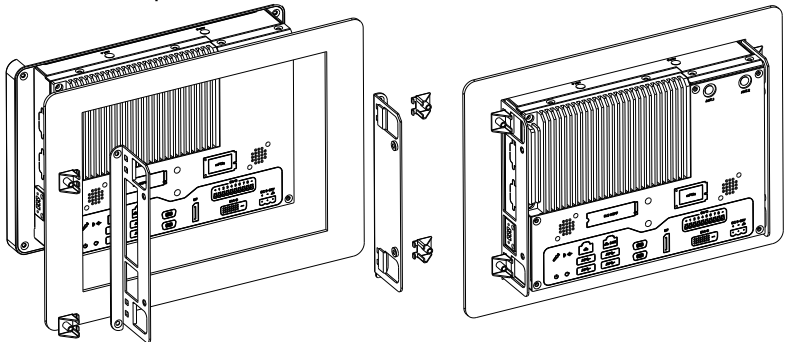

4.2.2. iTC-1101C VESA Mounting (Optional Accessory)

1. Put the panel PC into VESA bracket.
2. Put the provided VESA-mounting bracket into holes around edges of the panel PC.
3. Tightly fasten the VESA-mounting bracket around edges.

VESA Mount

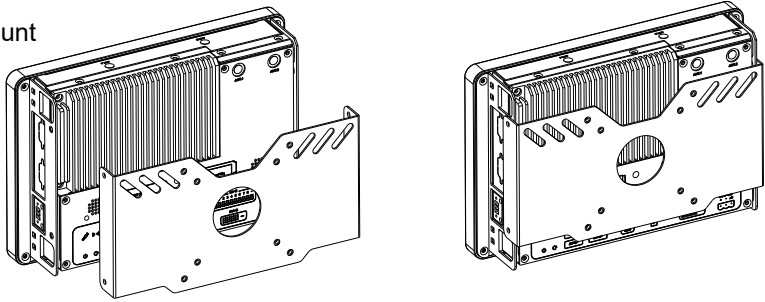

4.2.3. iTC-1121R / iTC-1150R / iTC-1170R Panel Mounting

1. Have the rubber O-ring included in accessory pack. Put the rubber O-ring on the panel PC.
2. Integrate the panel PC into a correct-sized frame on a wall or other devices.
3. Put the provided clamps into holes around edges of the panel PC then tightly fasten the clamps around edges of the panel PC as the picture below.

Note: In our case, we took a transparent stand as an example.

Panel Mount and Clamps

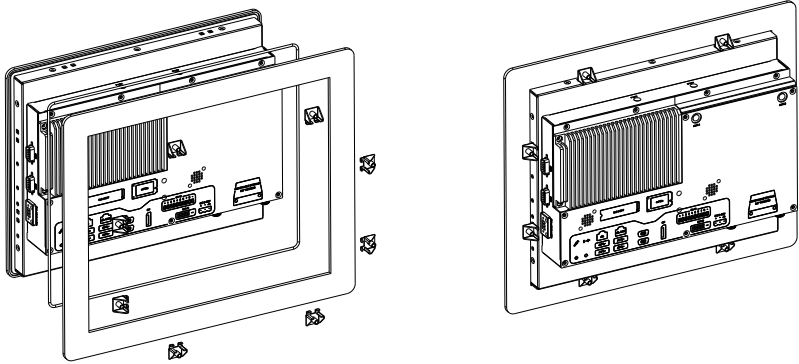

4.2.4. iTC-1121R / iTC-1150R / iTC-1170R VESA Mounting (Optional Accessory)

1. Have the VESA bracket included in accessory pack. Put the panel PC into VESA bracket.
2. Put the provided VESA-mounting bracket into holes around edges of the panel PC.
3. Tightly fasten the VESA-mounting bracket around edges.

VESA Mount

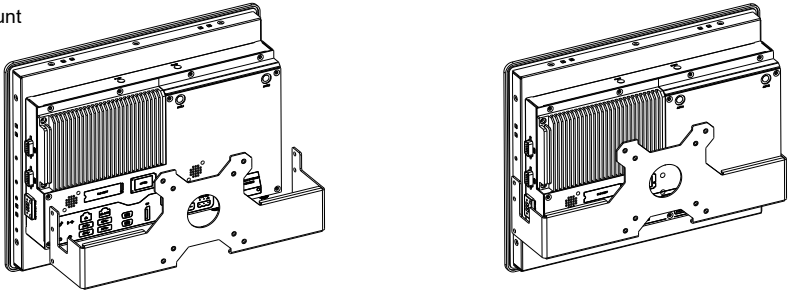

This page is intentionally left blank.

Chapter 5

BIOS

BIOS

The BIOS Setup utility for the iTC-11XX series are featured by American Megatrends Inc to configure the system settings stored in the system's BIOS ROM. The BIOS is activated once the computer powers on. When the computer is off, the battery on the main board supplies power to BIOS RAM.

To enter the BIOS Setup utility, keep hitting the "Delete" key upon powering on the computer.

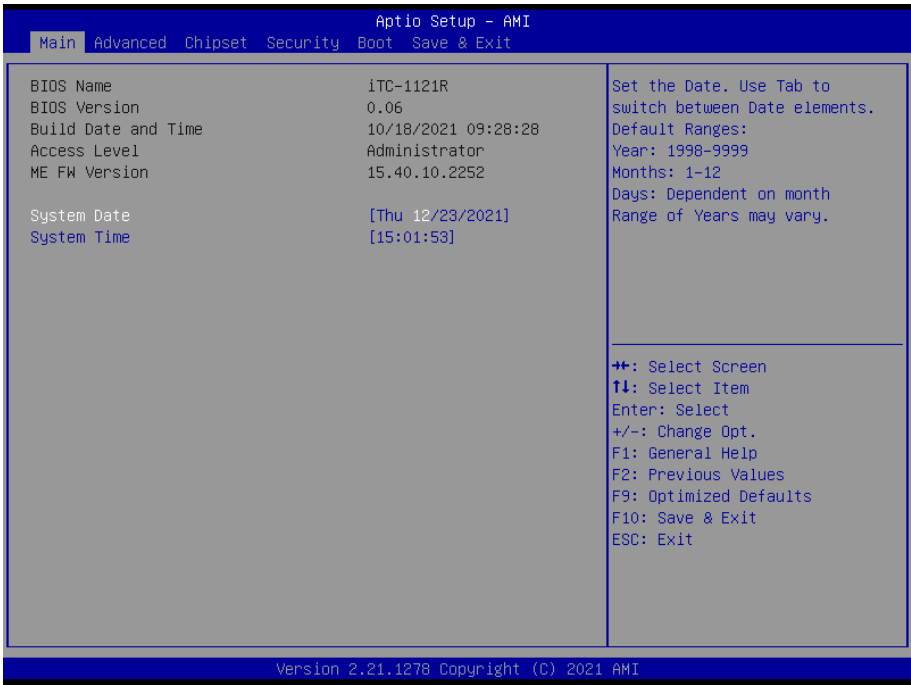

Menu	Description
Main	See 5.1. Main on page 40
Advanced	See 5.2. Advanced on page 41
Chipset	See 5.3. Chipset on page 109
Boot	See 5.4 Security on page 109
Security	See 5.5. Boot on page 109
Save & Exit	See 5.6. Save & Exit on page 109

Key Commands

The BIOS Setup utility relies on a keyboard to receive user's instructions. Hit the following keys to navigate within the utility and use the utility.

Keystroke	Function
← →	Moves left/right between the top menus.
↓ ↑	Moves up/down between highlight items.
Enter	Selects an highlighted item/field.
Esc	<ul style="list-style-type: none"> ▶ On the top menus: Use Esc to quit the utility without saving changes to CMOS. (The screen will prompt a message asking you to select OK or Cancel to exit discarding changes. ▶ On the submenus: Use Esc to quit current screen and return to the top menu.
Page Up / +	Increases current value to the next higher value or switches between available options.
Page Down / -	Decreases current value to the next lower value or switches between available options.
F1	Opens the Help of the BIOS Setup utility.
F10	Exits the utility saving the changes that have been made. (The screen then prompts a message asking you to select OK or Cancel to exit saving changes.)

Note: Pay attention to the "WARNING" that shows at the left pane onscreen when making any change to the BIOS settings.

This BIOS Setup utility is updated from time to time to improve system performance and hence the screenshots hereinafter may not fully comply with what you actually have onscreen.

5.1. Main

The **Main** menu features the settings of **System Date** and **System Time** and displays some BIOS info.

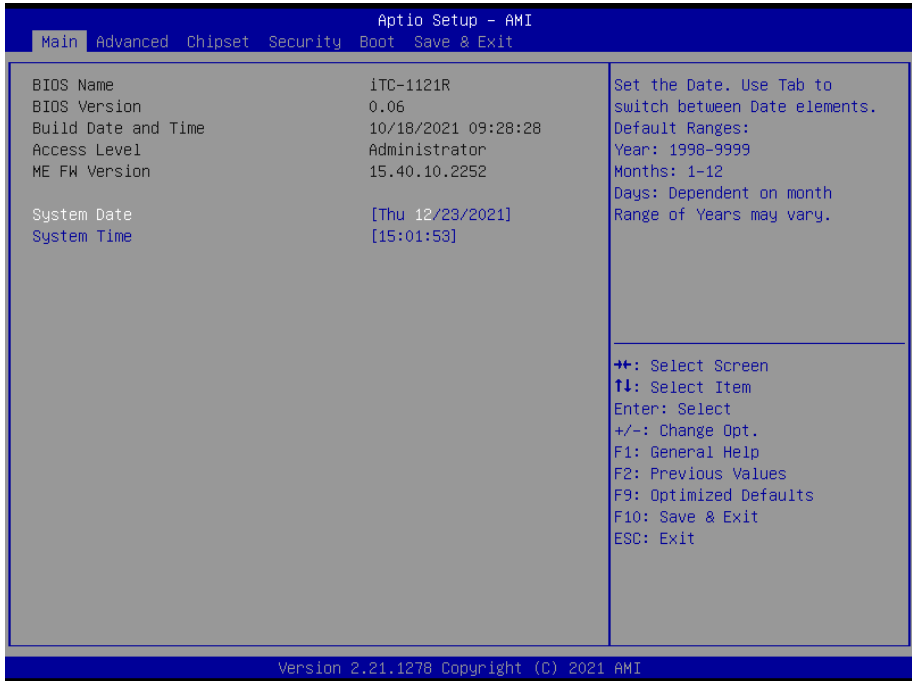

Setting	Description
BIOS Name	Delivers the model name of the computer.
BIOS Version	Delivers the computer's BIOS version.
Build Date and Time	Delivers the date and time when the BIOS Setup utility was made/ updated.
Access Level	Delivers the level that the BIOS is being accessed at the moment.
ME FW Version	Delivers the ME version.
System Date	Sets system date.
System Time	Sets system time.

5.2. Advanced



Setting	Description
CPU Configuration	See 5.2.1. CPU Configuration on page 42
Trusted Computing	See 5.2.2. Trusted Computing on page 43
ACPI Settings	See 5.2.3. ACPI Settings on page 44
Super IO Configuration	See 5.2.4. Super IO Configuration
Hardware Monitor	See 5.2.5. Hardware Monitor on page 46
S5 RTC Wake Settings	See 5.2.6. S5 RTC Wake Settings on page 47
PCI Subsystem Settings	See 5.2.7. PCI Subsystem Setting on page 48
USB Configuration	See 5.2.8. USB Configuration on page 49
Network Stack Configuration	See 5.2.9. Network Stack Configuration on page 51
NVMe Configuration	See 5.2.10. NVME Configuration on page 52

5.2.1. CPU Configuration

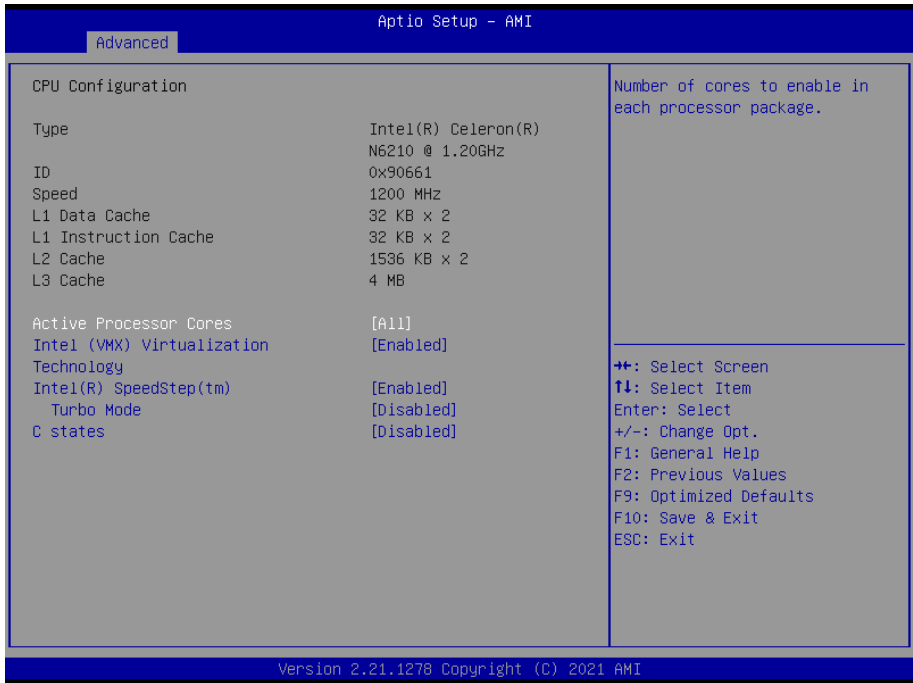

Setting	Description
Active Processor Cores	Numbers of cores to enable in each processor package
Intel Virtualization Technology	When enabled, a VMM can utilize the additional hardware capabilities provided by Vanderpool Technology ► Options: Enabled (default) or Disabled
Intel SpeedStep	Allows more than two frequency ranges to be supported Enable (default) / Disable Intel SpeedStep
Turbo Mode	Only available when Intel Speed Step is Enabled . Enable (default) / Disable Turbo Mode
CPU C States	Enable / Disable (default) CPU C States

5.2.2. Trusted Computing



Setting	Description
Security Device Support	Enable (default) or Disable BIOS support for security device.
Pending operation	Schedule an Operation for the security Device. Your computer will reboot during restart in order to change State of Security Device. ▶ Options: None (default) and TPM Clear

5.2.3. ACPI Settings



Setting	Description
Enable Hibernation	Enables (default) or Disables System ability to Hibernate (OS/S4 Sleep State). This option may be not effective with some OS.

5.2.4. Super IO Configuration

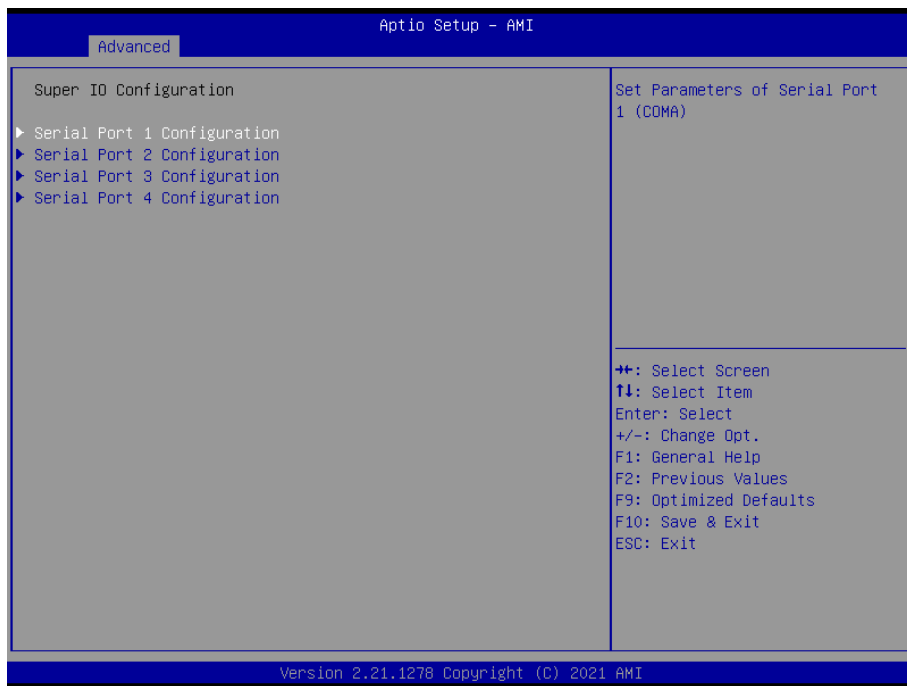

Setting	Description
Serial Port	Enable (default) or Disable Serial Port (COM).
Change Settings	Select an optimal setting for Super IO device. <ul style="list-style-type: none"> ▶ Options for Serial Port 1: Auto; IO=2F8h; IRQ=3 (default) ; Options for Serial Port 2: Auto; IO=2F8h; IRQ=3 (default) Options for Serial Port 3: Auto; IO=3E8h; IRQ=5 (default) Options for Serial Port 4: Auto; IO=2E8h; IRQ=6 (default)
Mode Select	Select RS-232 (default), RS-422 , RS-485 or RS-485 Termination Resistor

5.2.5. Hardware Monitor

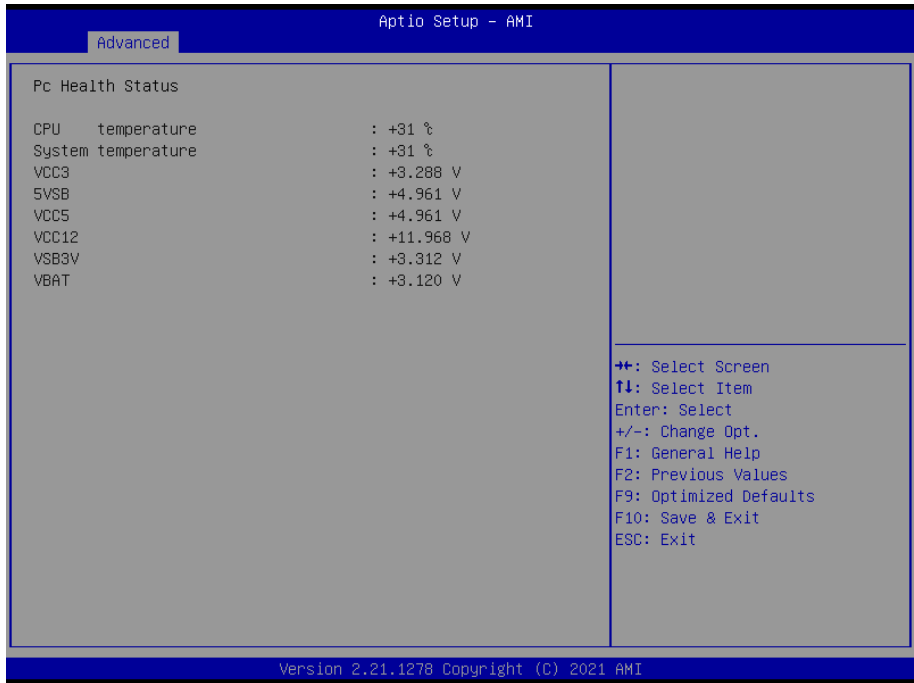

Select this submenu to view the main board’s hardware status. Select it to run a report of various info as depicted below:

5.2.6. S5 RTC Wake Settings



Setting	Description
Wake System from S5	<p>Enable or Disable (default) system wake on alarm event.</p> <ul style="list-style-type: none"> Options available are: <ul style="list-style-type: none"> Disabled (default): System will wake on the hr::min::sec specified. DynamicTime: If selected, you need to set Wake up minute increase from 1 - 5. System will wake on the current time + increase minute(s).

5.2.7. PCI Subsystem Setting

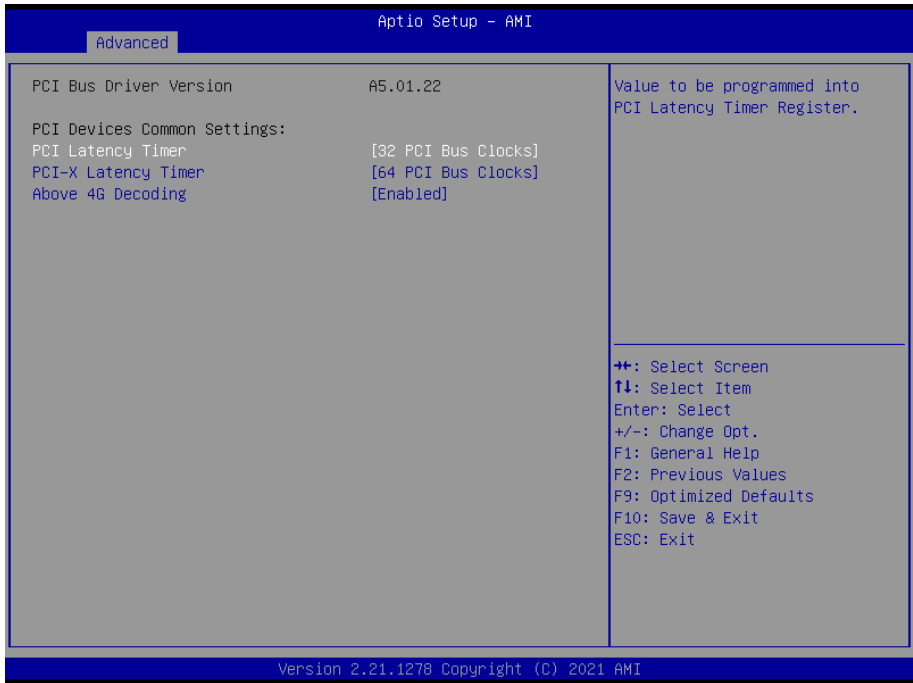

Setting	Description
PCI Latency Timer	Value to be programmed into PCI Latency Timer Register. ► Options: 32 (default), 64, 96, 128, 160, 192, 224 and 248 PCI Bus Clocks.
PCI-X Latency Timer	Value to be programmed into PCI-X Latency Timer Register. ► Options: 32, 64 (default), 96, 128, 160, 192, 224 and 248 PCI Bus Clocks.
Above 4G Decoding	Enable/Disable (default) 64bit capable Devices to be Decoded in Above 4G Address Space (Only if System Supports 64 bit PCI Decoding).

5.2.8. USB Configuration

Aptio Setup - AMI

Advanced

USB Configuration		<p>Enables Legacy USB support. AUTO option disables legacy support if no USB devices are connected. DISABLE option will keep USB devices available only for EFI applications.</p> <hr/> <p> ++: Select Screen ↑↓: Select Item Enter: Select +/-: Change Opt. F1: General Help F2: Previous Values F9: Optimized Defaults F10: Save & Exit ESC: Exit </p>
USB Module Version	25	
USB Controllers: 1 XHCI		
USB Devices: 1 Drive, 1 Keyboard, 1 Mouse		
Legacy USB Support	[Enabled]	
XHCI Hand-off	[Enabled]	
USB Mass Storage Driver Support	[Enabled]	
USB hardware delays and time-outs:		
USB transfer time-out	[20 sec]	
Device reset time-out	[20 sec]	
Device power-up delay	[Auto]	
Mass Storage Devices:		
KingstonDataTraveler 3.0PMAP	[Auto]	

Version 2.21.1278 Copyright (C) 2021 AMI

Setting	Description
Legacy USB Support	<p>Enables/disables legacy USB support.</p> <ul style="list-style-type: none"> ▶ Options available are Enabled (default), Disabled and Auto. ▶ Select Auto to disable legacy support if no USB device are connected. ▶ Select Disabled to keep USB devices available only for EFI applications.
XHCI Hand-off	<p>This is a workaround for Oses without XHCI hand-off support. The XHCI ownership change should be claimed by XHCI driver.</p> <ul style="list-style-type: none"> ▶ The optional settings are: Enabled (default) / Disabled.
USB Mass Storage Driver Support	<p>Enables/disables USB Mass Storage Driver Support.</p> <ul style="list-style-type: none"> ▶ The optional settings are: Disabled / Enabled (default).

USB hardware delay and time-out	
USB Transfer time-out	<p>Use this item to set the time-out value for control, bulk, and interrupt transfers.</p> <p>▶ Options: 1 sec, 5 sec, 10 sec, 20 sec (default).</p>
Device reset time-out	<p>Use this item to set USB mass storage device start unit command time-out.</p> <p>▶ Options available are: 10 sec, 20 sec (default), 30 sec, 40 sec</p>
Device power-up delay	<p>Use this item to set maximum time the device will take before it properly reports itself to the host controller. 'Auto' uses default value: for a root port it is 100 ms, for a hub port the delay is taken from hub descriptor.</p> <p>▶ Options available are:</p> <p>Auto: Default</p> <p>Manual: Select Manual you can set value for the following sub-item: 'Device Power-up delay in seconds', the delay range in from 1 to 40 seconds, in one second increments.</p>

5.2.9. Network Stack Configuration



Setting	Description
Network Stack	Enable or Disable (default) UEFI network stack.

5.2.10. NVME Configuration

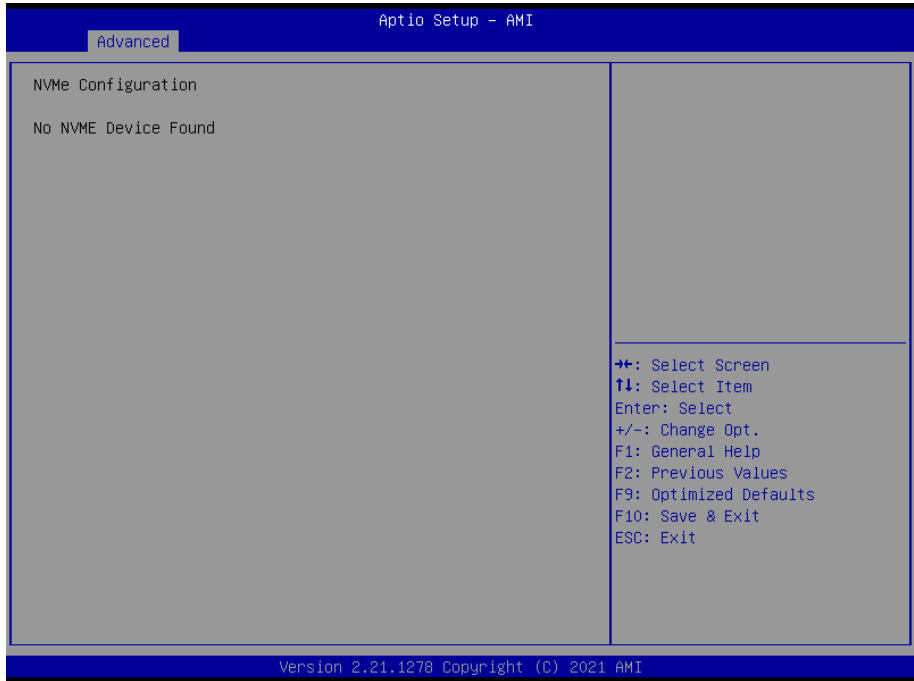

Access this submenu to view the NVMe controller and driver information.

5.3. Chipset

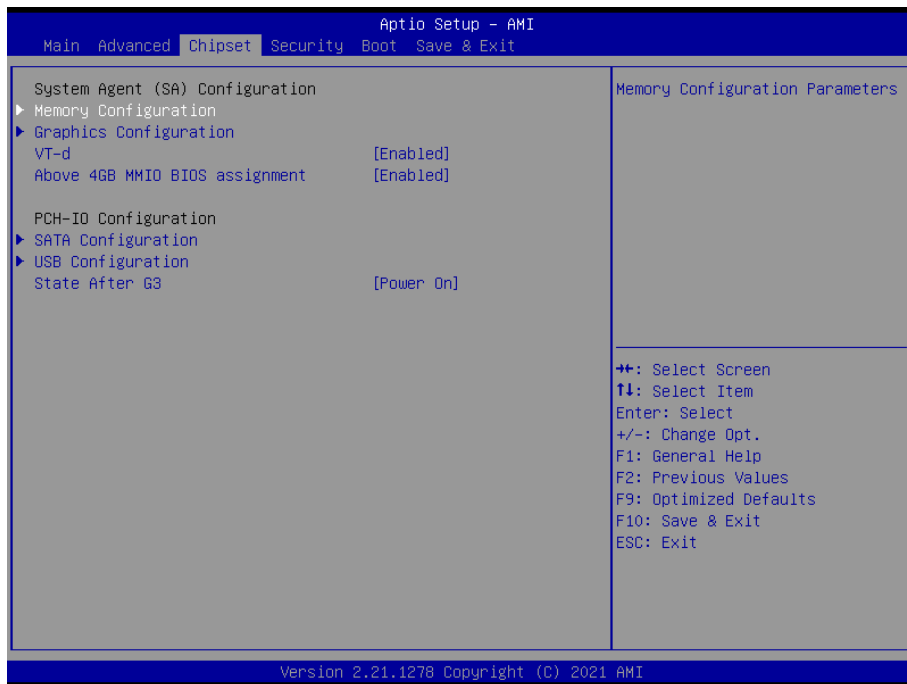

The features settings are:

Setting	Description
System Agent (SA) Configuration	
Memory Configuration	Access this submenu to view the memory configuration.
Graphics Configuration	See 5.3.1.1. Graphics Configuration on page 109
PEG Port Configuration	PEG port options Enable Root Port: Enable or Disable the root port. ▶ Options: Auto (default), Enabled and Disabled . Max Link Speed: Configure PEG 0:1:0 Max Speed. ▶ Options: Auto (default), Gen1 , Gen 2 and Gen3 .
VT-d	Enable (default) or Disable VT-d function
Above 4GB MMIO BIOS assignment	Enable or Disable (default) Above 4GB MMIO BIOS assignment. This is enabled automatically when aperture size is set to 2048MB.

PCH-IO Configuration	
SATA And RST Configuration	See 5.3.1.2. SATA And RST Configuration on page <?>
USB Configuration	See 5.3.1.3. USB Configuration on page 109
State After G3	Specify what state to go to when power is re-applied after a power failure (G3 state). ▶ Options available are Power On (default), Power Off and Last State .

5.3.1. Graphics Configuration

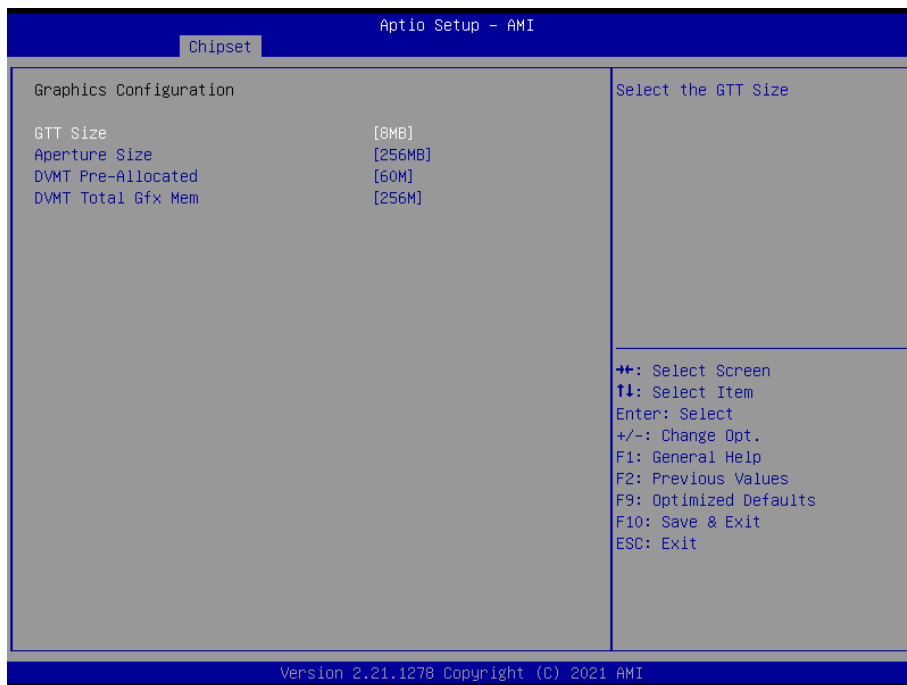

Setting	Description
GTT Size	Select the GTT Size. ▶ Options: 4MB, 2MB and 8MB (default).
Aperture Size	Select the Aperture Size. Note that above 4GB MMIO BIOS assignment is automatically enabled when selecting 2048MB aperture. To use this feature, please disable CSM support. ▶ Options: 128MB, 256MB (default), 512MB, 1024MB and 2048MB
DVMT Pre-Allocated	Select the DVMT 5.0 Pre-allocated (Fixed) Graphic Memory size used by the Internal Graphic Device. ▶ 60M is the default.
DVMT Total Gfx Mem	Select the DVMT 5.0 Total Graphic Memory size used by the Internal Graphic Device. ▶ Options: 128M, 256M (default) and Max .

5.3.2. SATA And RST Configuration

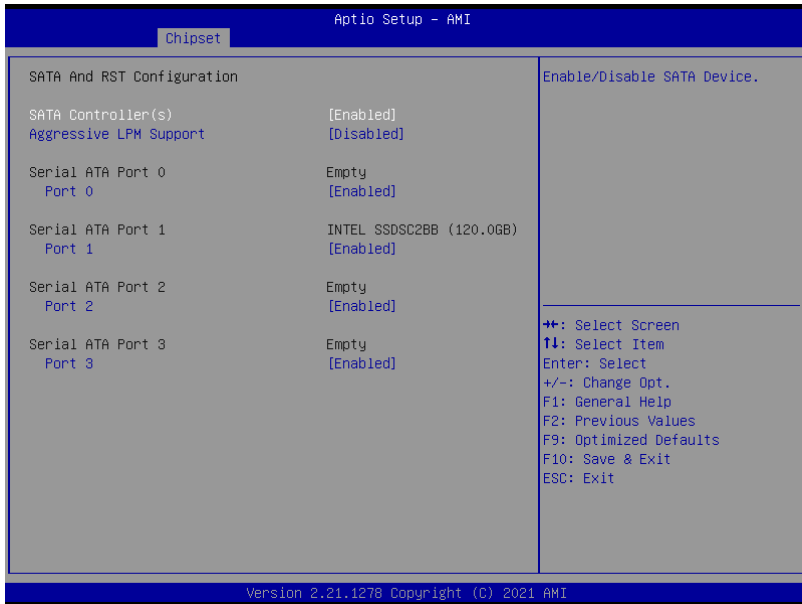

Setting	Description
SATA Controller(s)	Enables (default) / Disables SATA device(s).
Aggressive LPM Support	Enables / Disables (default) PCH to aggressively enter link power state.
Serial ATA Port 0~3	SATA device information. Enables (default) / Disables the SATA port. *Available SATA ports depend on your model.

5.3.3. USB Configuration

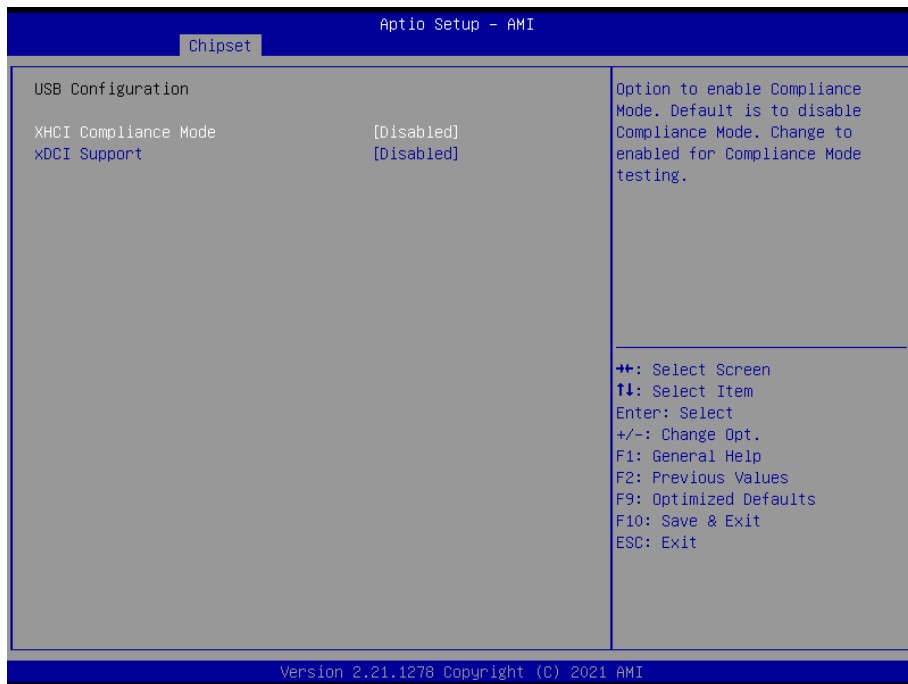

Setting	Description
XHCI Disable Compliance Mode	Options to disable Compliance Mode. Default is FALSE (default) to not disable Compliance Mode. Set TRUE to disable Compliance Mode.
xDCI Support	Enable / Disable (default) xDCI (USB OTG Device).

5.4. Security

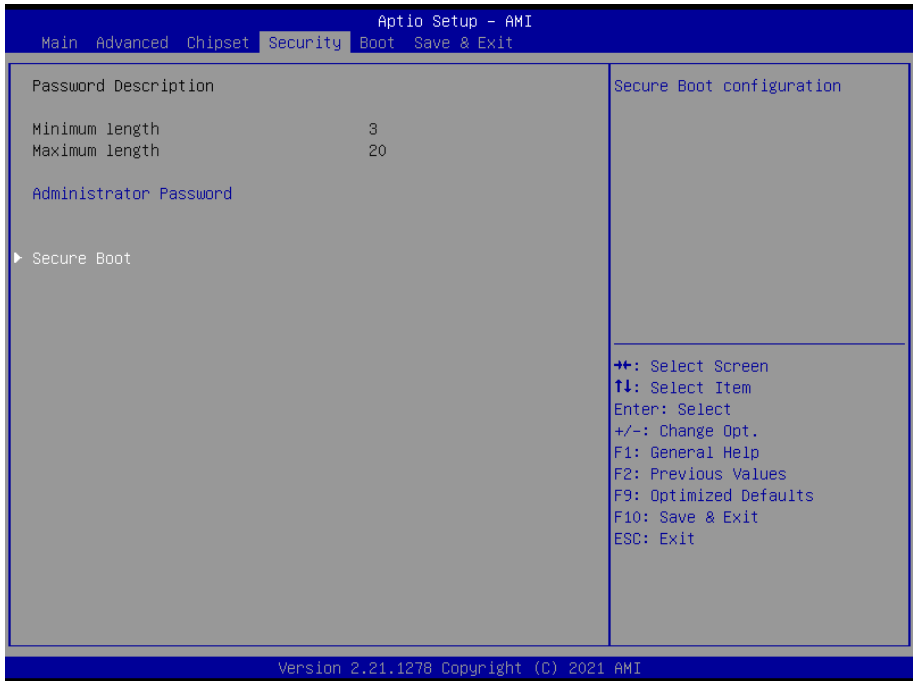

Setting	Description
Administrator Password	To set up an administrator password: 1. Select Administrator Password . 2. An Create New Password dialog then pops up onscreen. 3. Enter your desired password that is no less than 3 characters and no more than 20 characters. 4. Hit [Enter] key to submit.
Security Boot	See 5.4.1 Security Boot on page <?> .

5.4.1. Security Boot



Setting	Description
Secure Boot	Enable/Disable (default) secure boot.
Secure Boot Mode	Allow users to set the secure boot selector. Standard/Custom (default) mode.
Restore Factory Keys	Force system to restore default secure boot key database.
Reset to Setup Mode	Delete all secure boot key databases.
Key Management	Allow users to modify secure variables and set key management page.

5.5. Boot

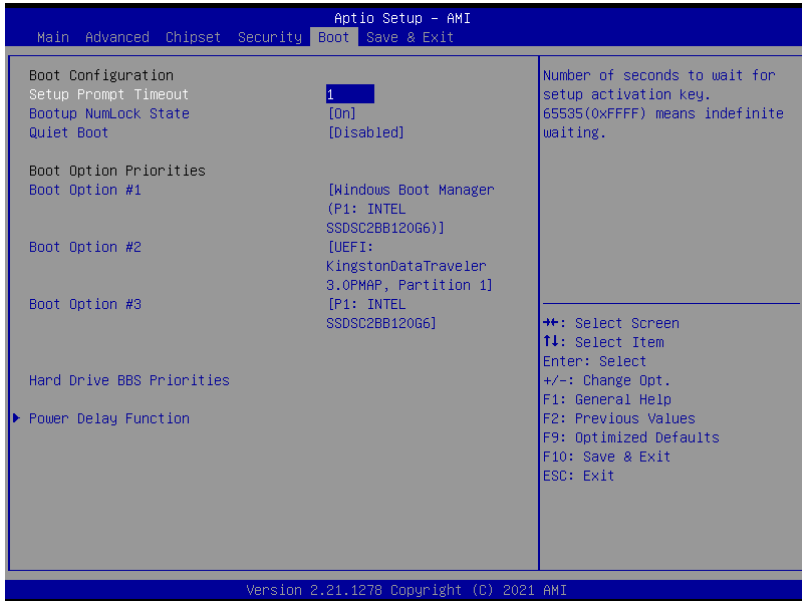

Setting	Description
Setup Prompt Timeout	<p>Set how long to wait for the prompt to show for entering BIOS Setup.</p> <ul style="list-style-type: none"> ▶ The default setting is 1 (sec). ▶ Set it to 65535 to wait indefinitely.
Bootup NumLock State	<p>Sets whether to enable or disable the keyboard's NumLock state when the system starts up.</p> <ul style="list-style-type: none"> ▶ Options available are On (default) and Off.
Quiet Boot	<p>Sets whether to display the POST (Power-on Self Tests) messages or the system manufacturer's full screen logo during booting.</p> <ul style="list-style-type: none"> ▶ Select Disabled to display the normal POST message, which is the default.
Boot Option Priority	<p>Set the system boot priorities.</p>
Hard Drive BBS Priorities	<p>Sets the order of the legacy devices in this group. BBS means "BIOS Boot Specification".</p>

Power Delay Function	<p>Power Delay Function</p> <p>Set the system support power delay function.</p> <ul style="list-style-type: none">▶ Options: Enable (default): Support power delay function. Disable: Power on/off manually operated. <p>Power on delay</p> <p>Select the time which the system will power on.</p> <ul style="list-style-type: none">▶ Options: Manually Operator (default), 04 Seconds, 08 Seconds and 16 Seconds. <p>Power off delay</p> <p>Select the time which the system will shutdown.</p> <ul style="list-style-type: none">▶ Options: Manually Operator (default), 30 Seconds, 60 Seconds and 90 Seconds.
-----------------------------	---

5.6. Save & Exit

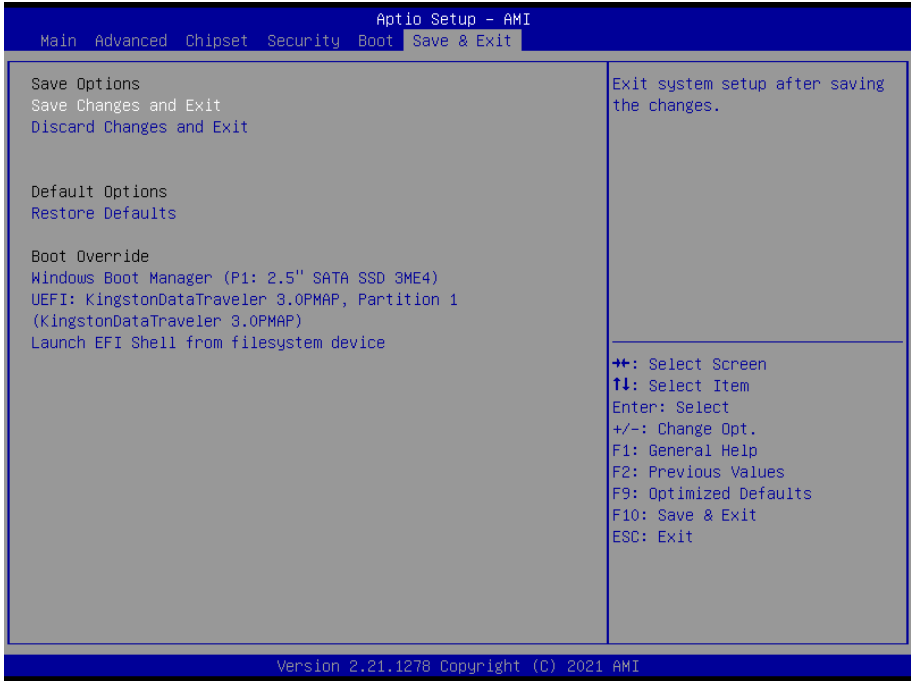

The features settings are:

Setting	Description
Save Changes and Reset	Saves the changes and quits the BIOS Setup utility.
Discard Changes and Exit	Quits the BIOS Setup utility without saving the change(s).
Restore Defaults	Restores all settings to defaults. <ul style="list-style-type: none"> ▶ This is a command to launch an action from the BIOS Setup utility.
Boot Override	Boot Override presents a list in context with the boot devices in the system. <ul style="list-style-type: none"> ▶ P0: Select the device to boot up the system regardless of the currently configured boot priority. ▶ Launch EFI Shell from filesystem device: Attempts to launch EFI Shell Application (Shell.efi) from one of the available filesystem devices.